

THE INFORMATION CONTAINED IN THIS DRAWING IS THE SOLE PROPERTY OF VTE INCORPORATED. ANY REPRODUCTION IN PART OR WHOLE WITHOUT THE WRITTEN PERMISSION OF VTE INCORPORATED IS PROHIBITED. VTE MAKES NO WARRANTY, EXPRESSED OR IMPLIED, AS TO THE SUITABILITY OF A PRODUCT FOR ANY INTENDED USE. THE CUSTOMER SHALL BEAR THE SOLE RESPONSIBILITY OF DETERMINING THE SUITABILITY OF ANY VTE PRODUCT FOR ITS END USE.

LTR.	REVISIONS	DATE	INT.
△	REDRAWN AND UPDATED ( ORIGINAL DRAWING 7-25-14 )	06-17-19	RAS

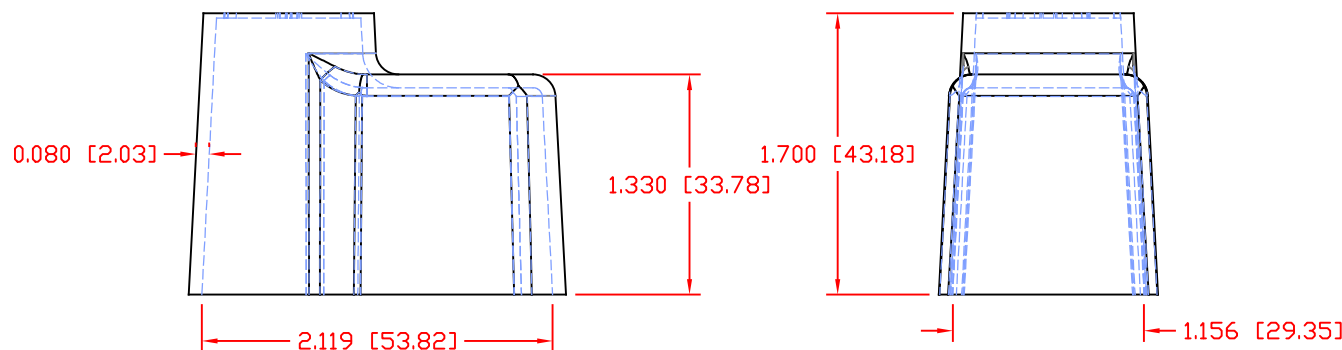
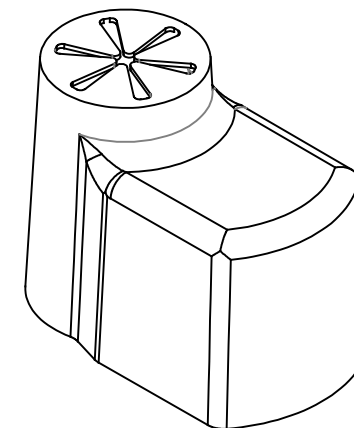
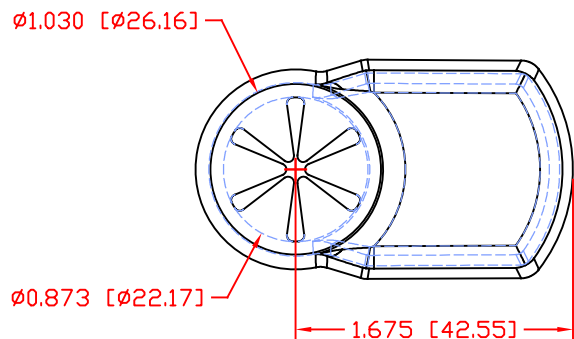

SCALE FACTOR : NONE  
 ALL DIMENSIONS GIVEN AS: in [mm]  
 TOLERANCES UNLESS OTHERWISE SPECIFIED :  
 MOLDED PARTS: ±.030" [±0.8mm]  
 ALL ANGLES ARE ± 1 DEGREE

MATERIAL PART NO:	1101650114
MATERIAL:	PVC
VENDOR PART NO:	9812-65-BLACK
SHORE DUROMETER:	"A" 10 SEC. 65
SPECIFIC GRAVITY:	1.34
ULT. ELONGATION %:	400
MELTING TEMP:	315-335 F [157-168 C]
BRITTLE TEMP:	-54 F [-48 C]
TENSILE STRENGTH PSI:	1550 PSI
DIELECTRIC STRENGTH, V./mil	453
U.L. RATING:	V2



VTE Incorporated  
 5437 Robinson Road, P.O. Box 790  
 Pellston, Michigan 49769  
 Telephone: 1-800-527-9256, 231-539-8000  
 FAX: 231-539-0914

REF:	DATE:	DRN BY:	RAS	WEIGHT:
CUSTOMER DIMS	6-17-19	CHK'D BY:	PJK	
TITLE: BATTERY TERMINAL INSULATOR				
MATERIAL:	PVC	PART NO.		
COLOR: BLACK	DRG CLASS REV A	968N9V14		