

THE INFORMATION CONTAINED IN THIS DRAWING IS THE SOLE PROPERTY OF VTE INCORPORATED. ANY REPRODUCTION IN PART OR WHOLE WITHOUT THE WRITTEN PERMISSION OF VTE INCORPORATED IS PROHIBITED. VTE MAKES NO WARRANTY, EXPRESSED OR IMPLIED, AS TO THE SUITABILITY OF A PRODUCT FOR ANY INTENDED USE. THE CUSTOMER SHALL BEAR THE SOLE RESPONSIBILITY OF DETERMINING THE SUITABILITY OF ANY VTE PRODUCT FOR ITS END USE.

LTR.	REVISIONS	DATE	INT.
	UPDATED TORQUE VALUES FROM 180 IN-LBS [20.34 Nm]	2-03-18	RAS
	UPDATED DIMENSION OF 361N5 BASE	10-28-20	EJE

USE GREENLEE PUNCH
ASSEMBLY #60098
FOR PANEL CUTOUT

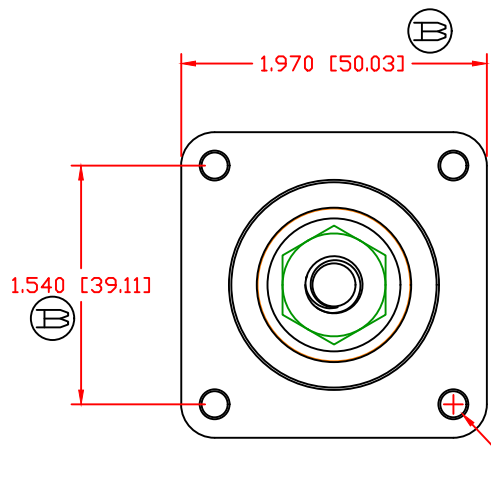
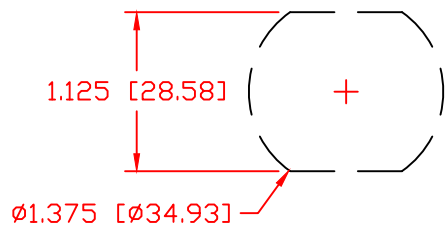

ASSEMBLY
CCFB376N14W
CONSIST OF :

- 1-CCFB376N14
POWER BUSHING
- 1-3960-002
SEALING GASKET
- 1-232N3V14
INSULATOR BOOT

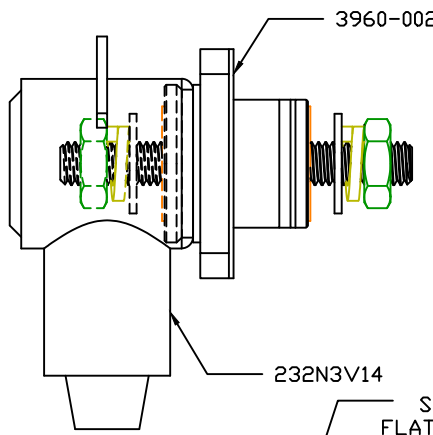

P/N 3960-002
.062 THICK CF 4480 81 DUROMETER
FIBERGLASS REINFORCED SILICONE
PRESS PAD SEALING GASKET

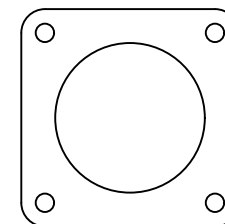

3844-012 3/8"-16
STAINLESS STEEL
JAM NUT (2) REQ'D

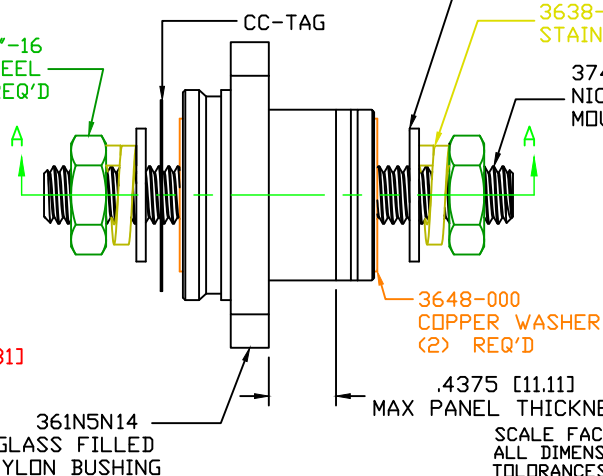

3646-000
STAINLESS STEEL
FLAT WASHER (2) REQ'D

3638-000 LOCK WASHER
STAINLESS STEEL (2) REQ'D

3742-007
NICKEL PLATED
MOUNTING STUD

3863-000
COPPER CORE

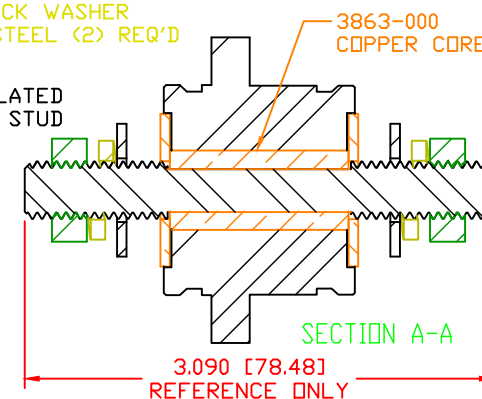

SCALE FACTOR : NONE
ALL DIMENSIONS GIVEN AS: in [mm]
TOLERANCES UNLESS OTHERWISE SPECIFIED :
MOLDED PARTS: ±.030" [±0.8mm]
HARDWARE ITEMS: ±.010" [±0.25mm]

MAXIMUM FASTENER TORQUES:
JAM NUTS: 212 IN-LBS [24.0 Nm]

CURRENT CARRYING CAPACITY:
DUTY CYCLE: 80%
CURRENT CAPACITY: 5.2 Kw (440 AMP @ 12VDC)
TEMPORARY MAX (12 MINUTES): 6.6 Kw (550 AMP @ 12VDC)

MATERIAL PART NO: 1111210514UL
MATERIAL: GLASS FILLED NYLON
VENDOR PART NO: NYLON N2015 HL BK
SPECIFIC GRAVITY: 1.23
MELTING TEMP: 515 F [268 C]
U.L. RATING: UL 94 HB



VTE Incorporated
5437 Robinson Road, P.O. Box 790
Pellston, Michigan 49769
Telephone: 1-800-527-9256, 231-539-8000
FAX: 231-539-0914

REF: CUSTOMER DIMS	DATE: 11-16-17	DRN BY: RAS	WEIGHT:
		CHK'D BY: PJK	
TITLE: 3/8" PANEL MOUNT POWER BUSHING, COPPER CORE			
MATERIAL: GLASS FILLED NYLON		PART NO. CCFB376N14W	
COLOR: BLACK	DRG CLASS	REV B	